

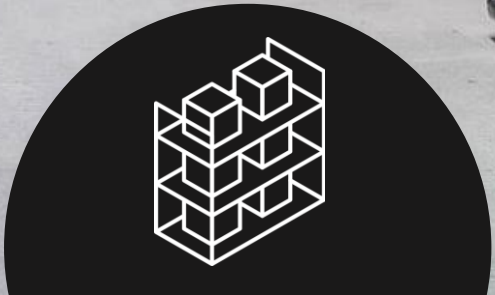

doks.

WELCOME TO THE FUTURE OF
WAREHOUSE MANAGEMENT

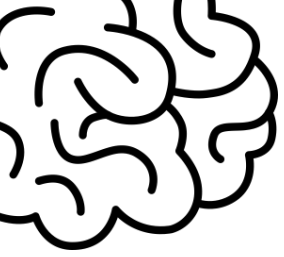



Herausragende Talente führen doks. in die Zukunft

THE TEAM



Mike Becker
Co-Founder

Chief Technology Officer
M. Sc. Computer Science
Duales Studium Informatik - B.Braun
Melsungen AG
Software Entwickler
– Aibotix GmbH (Drohnen Hersteller)

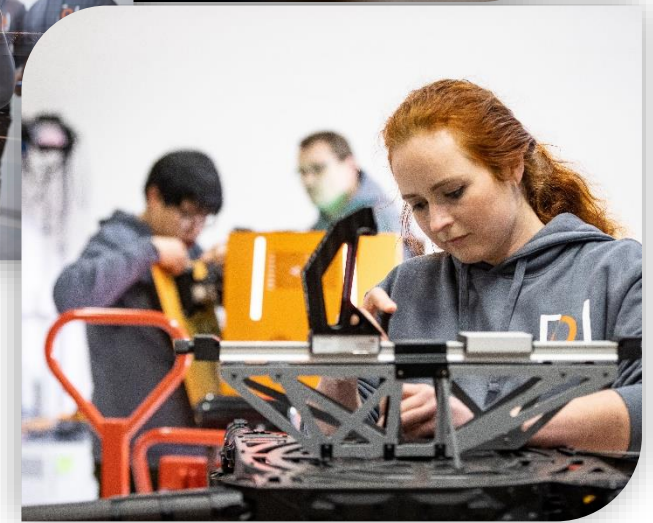



Überlegene Lösungen und starker USP CHALLENGES IN DER LOGISTIK



Logistikmarkt wächst jährlich rapide an



Schwierig qualifiziertes Personal zu finden



Die Umsätze steigen, während Fullfillment hinterherhinkt



KI basierende Vorhersagen werden zum Wettbewerbsvorteil

Mangelnde Transparenz und viele individuelle Probleme schmälern die Produktivität

KEIN LAGER IST VOLLSTÄNDIG TRANSPARENT



Nicht wertschöpfend

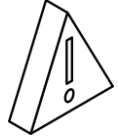

Bindet wertvolle Arbeitskräfte



Ungenauere Bestandsdaten

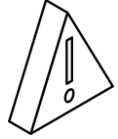

Beeinträchtigung der Lieferfähigkeit durch ungenaue Bestandsdaten



Umsatzverluste



TEUER



GEFÄHRLICH



UNBELIEBT

Höchste Transparenz im Lager mit
KI-basierter innovativer Software und Lösungen

THE DOKS. TECHNOLOGY



Robotik und Automatisierung



Sensor Technologie und Digitalisierung



Künstliche Intelligenz und
Maschinelles Lernen



- ✓ Autonomes und sicheres Arbeiten im Lager
- ✓ Maximale Genauigkeit und Transparenz
- ✓ Dauerhaft effiziente Lagerhaltung und Bestandserfassung
- ✓ Wettbewerbsvorteile durch KI-basierte Planung

THE DOKS. EFFECT

Abdeckung des gesamten Materialflusses vom Wareneingang bis zum fertigen Produkt

TRANSPARENZ

Inbound,
Outbound,
Intralogistics

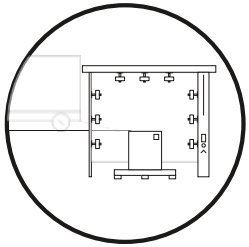

doks.summairy
gate



Bodenblock -
indoor

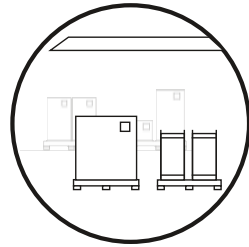

doks.summairy
ceiling



Hochregal -
indoor

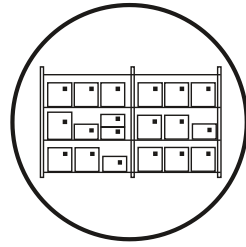

doks.inventairy



Bodenblock -
outdoor



doks.summairy
sky



doks.inventory

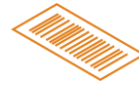

Barcode- und 2D-Code-
Erkennung und Abgleich



Vollständig autonomer Betrieb 24/7



5 Stunden kontinuierliche Flugzeit



Datenqualität > 99%



Minimaler Integrationsaufwand



Kosten- und Zeitersparnis

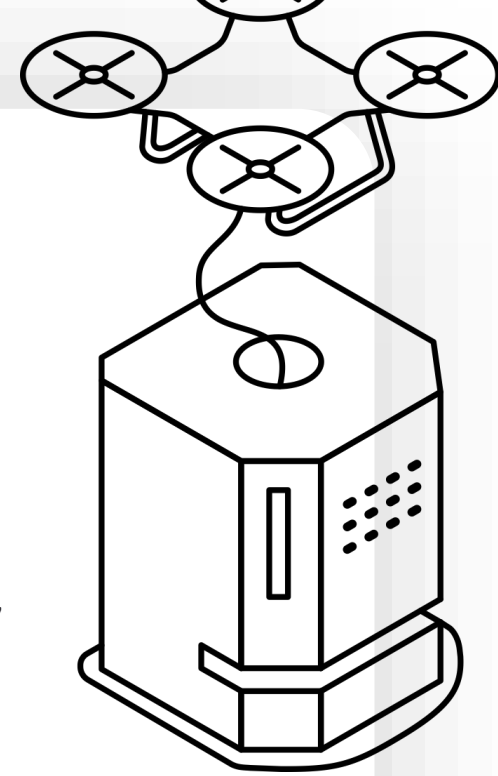



doks.summairy

sky



Datenaufnahme aus der Luft



Bis zu 97% Zeitersparnis



Steigerung der Genauigkeit um mehr als 65 %



Kostenreduzierung



Maximale Transparenz

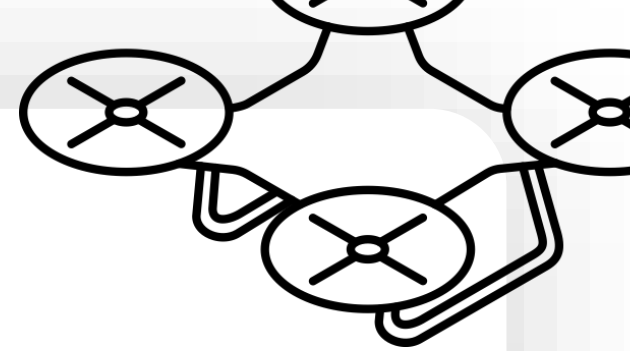



doks.summairy

ceiling

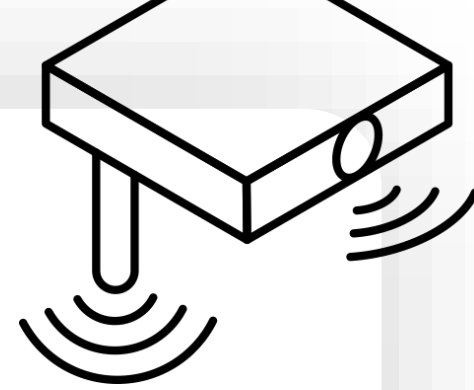

Datenaufnahme aus der Luft



Kein Operator notwendig



Bis 90% Zeitersparnis



Kostenreduzierung um bis zu 55%



Maximale Transparenz

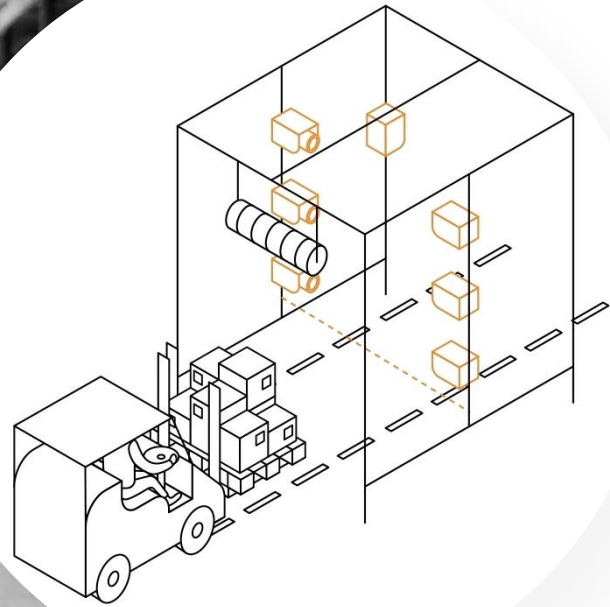

doks.summairy

gate



Verbindung zwischen In- & Outbound



Vollständige Dokumentation des Gutes



Kosten- und Zeitersparnis von bis zu 90%



Lager und Verladevorbereitung



Barcode und Stammdatenerfassung

Verknüpfung von Daten, um volle Transparenz im Lager und Materialfluss zu erreichen

THE DOKS.SOLUTION

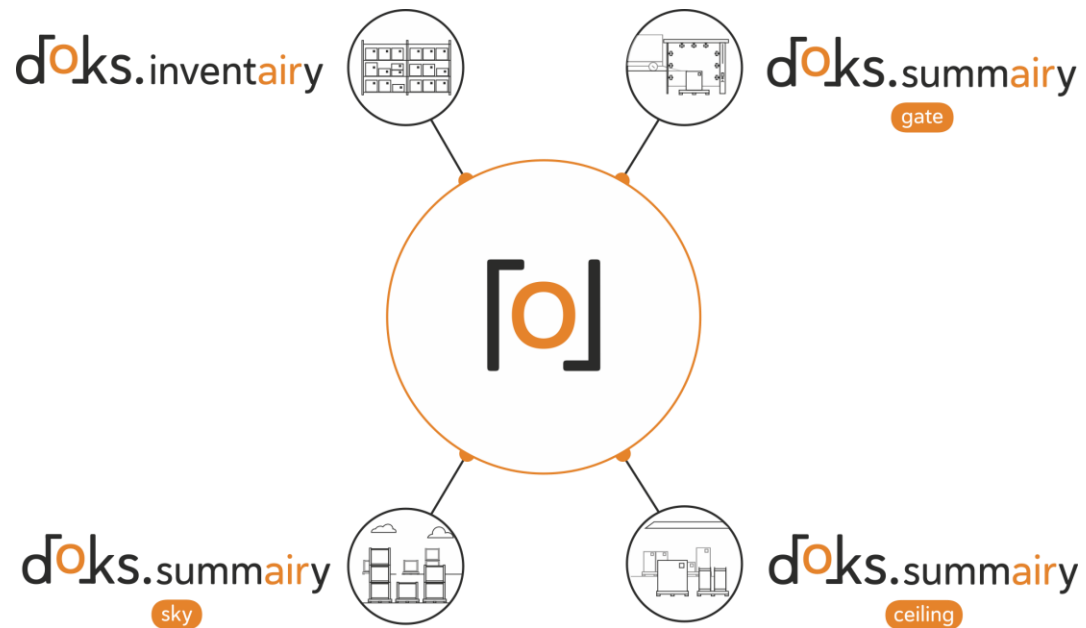

SICHER



AUTOMATISIERT



TRANSPARENT



Mike Becker

CTO & Co-Founder

mike.becker@doks-innovation.com

doks.innovation GmbH

Ludwig-Erhard-Str. 10

34131 Kassel